



PORTAS INTERIORES

Porta com friso sobre MDF
Carvalho



PORTAS

Em estilo contemporâneo, elegante ou arrojado, a JULAR oferece uma gama de portas interiores de qualidade, disponíveis em diferentes materiais e acabamentos.



Porta com friso sobre MDF
Wengé



Porta lisa simples
Zebrano Compósito



Série PREMIUM

Gama de portas interiores em favo MDF, com acabamento a verniz.
Disponível em porta única ou como bloco-porta em kit (inclui aro, guarnição,
fechadura e dobradiças).

Escolha em madeira simples, combinação de duas madeiras ou inclusão de vidro.



Porta lisa simples - Carvalho
L-VA5



Porta lisa - Carvalho
L-VA4



Porta lisa - Mutene
L-VA3



Porta lisa simples - Carvalho
L-VA20



Porta lisa - Cerejeira Americana
L-VA18



Porta lisa - Nogueira
L-VA23



Porta lisa simples
Carvalho

Série PREMIUM

Opções de combinação de duas madeiras ou inclusão de vidro.



Porta 2 madeiras
Carvalho/Wengé
L-VA21



Porta 2 madeiras
Faia Vaporizada/Wengé
L-VA14



Porta 2 madeiras
Faia Vaporizada/Wengé
L-VA17



Porta 2 madeiras
Wengé/Faia Vaporizada
L-VA27



Porta com vidro - Carvalho
L-VA1RDV1A



Porta com vidro - Tola
L-VA1REV1A



Porta decorativa lisa com inlay
Carvalho, inlay Tola

Série DECOLINE

Gama de portas decorativas para interior com inlay em folha de madeira.
Fabrico com favo MDF e acabamento a verniz.
Disponível em porta única ou como bloco-porta em kit (inclui aro, guarnição, fechadura e dobradiças).



Afizélia, inlay Tola
D-VI11



Faia Vaporizada, inlay Nogueira
D-VI19



Carvalho, inlay Nogueira
D-VI3



Faia Vaporizada, inlay Nogueira
D-VI9



Nogueira, inlay Tola
D-VI14



Nogueira, inlay Tola
D-VI20



Porta com friso sobre MDF
Wengé

Série TOPLINE

Gama de portas decorativas para interior com friso em baixo relevo sobre MDF. Fabrico com favo MDF e acabamento a verniz. Frisado em diferentes opções. Disponível em porta única ou como bloco-porta em kit (inclui aro, guarnição, fechadura e dobradiças).



Maple
T-VF18

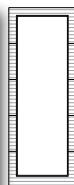

Cerejeira Americana
T-VF20



Mutene
T-VF12



Mogno
T-VF15

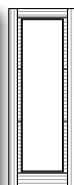

Nogueira
T-VF28



Wengé
T-VF13



Porta lacada lisa
Branco mate

Série SNOW

Gama de portas lisas ou pantografadas para interior, com acabamento a verniz ou lacado.

Disponível em porta única ou como bloco-porta em kit (inclui aro, guarnição, fechadura e dobradiças).



Porta lisa lacada
Branco mate
W-VS0



Porta pantografada lacada
Branco mate
W-VJ7KD2



Porta lacada com vidro central
Branco mate/vidro preto
W-VV30



Porta de segurança metálica
interior/exterior
Branco

MULTIUSOS

A gama de portas oferecida pela JULAR inclui também portas de segurança (interior/exterior), portas multiusos e portas corta-fogo. Diferentes cores e materiais e diversas possibilidades. Consulte-nos!



Porta metálica multiusos
Branco



Porta metálica multiusos
Faia Rosada



Porta metálica multiusos
Carvalho



Porta corta-fogo
Branco



Porta corta-fogo
Faia



Porta corta-fogo
Carvalho

ACABAMENTOS

Folha de Madeira Natural (apenas para portas interiores)



Afizélia



Câmbala



Carvalho Compósito



Carvalho Europeu



Carvalho



Castanho



Cerejeira Brasileira



Cerejeira Americana



Ébano Compósito



Freixo



Eucalipto



Izombé



Maple



Mogno



Mutene



Nogueira



Pinho



Sucupira



Tola



Wengé



Wengé Compósito



Zebrano Compósito

HPL Alto Brilho



Rosa



Branco



Azul Eléctrico



Vermelho Fogo



Amarelo Vulcano



Verde Lima

Vidros



Incolor

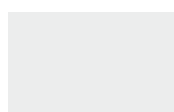

Fosco



Lacado Preto

DETALHES TÉCNICOS

Série PREMIUM

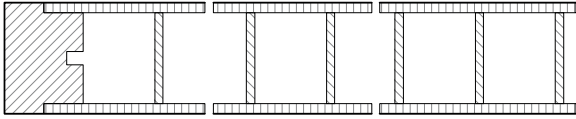

Série DECOLINE

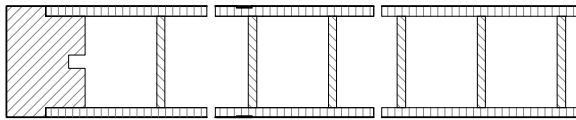

Série TOPLINE

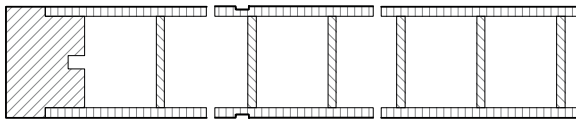

Série SNOW

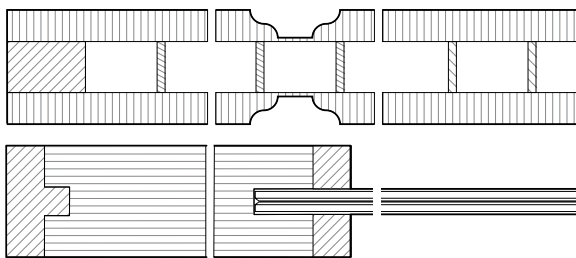

BLOCO-PORTA (kit)

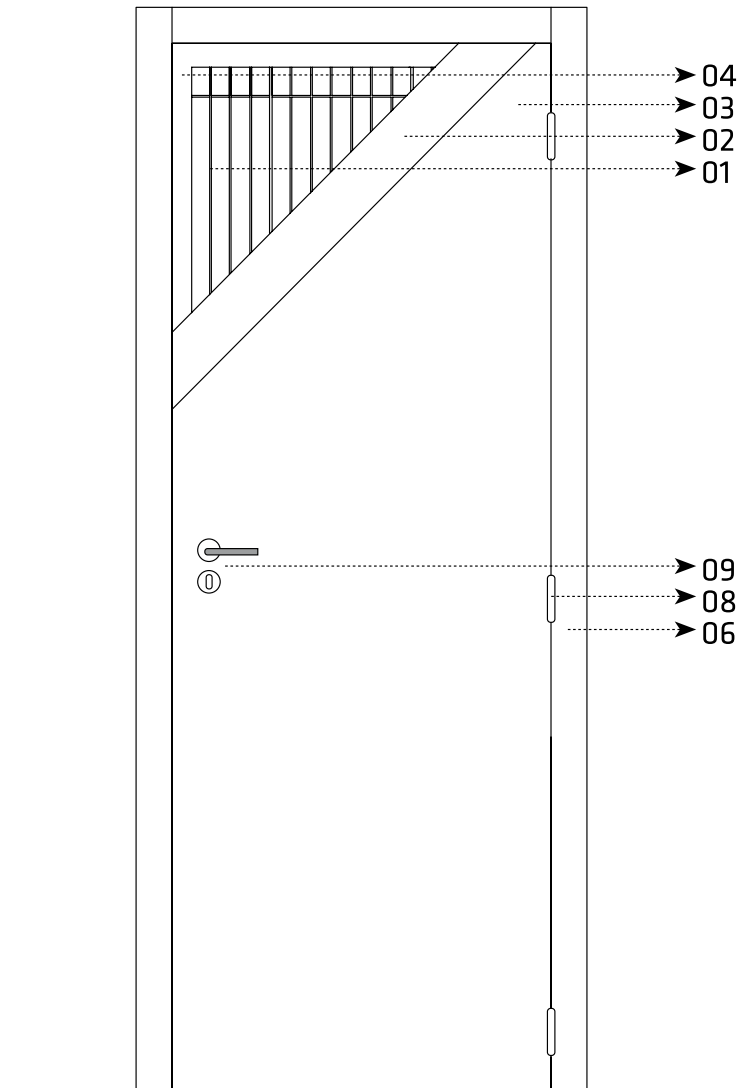

- 01 Estrutura interior em favo MDF
- 02 Painel MDF
- 03 Revestimento (folha de madeira ou outro)
- 04 Orla
- 05 Aro
- 06 Guarnição
- 07 Borracha batente
- 08 Dobradiça reversível
- 09 Fechadura

Porta: dimensões standard 2000x600 a 800 mm (intervalos de 50 em 50 mm).

Bloco-Porta em kit composto por: porta em favo MDF, aro lamelado em pinho maciço folheado e envernizado, guarnição de 70 mm extensível em contraplacado folheado (guarnição em MDF nos produtos lacados), fechadura, caixa de fechadura, dobradiças e acabamento a verniz.

Fornecimento em kit desmontado.

Não inclui puxadores, vidros, transporte e instalação.



LISBOA

mail@jular.pt

AZAMBUJA

azambuja@jular.pt

FÁTIMA

fatima@jular.pt

PORTO

porto@jular.pt

ALGARVE

algarve@jular.pt

NÚMERO AZUL

808 262 808

www.jular.pt



Management
System
ISO 9001:2015
ISO 14001:2015

www.tuv.com
ID 9105054953

